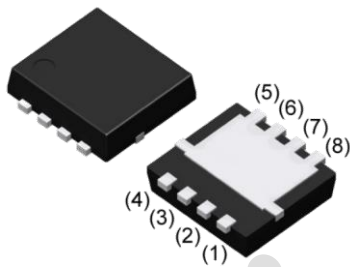


**Description**
**30V N-CHANNEL ENHANCEMENT MODE POWER MOSFET**
**Features**

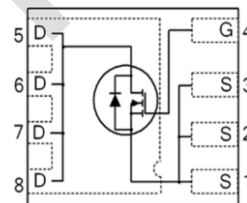
- Device Rating  $V_{DS} = 30V$ ,  $I_D = 139A$
- $R_{DS(ON)} = 3.0m\Omega$  (typ.) @  $V_{GS} = 10V$ ,  $I_D = 30A$
- Proprietary High Density Trench Technology
- RoHS Compliant & Halogen-Free

**Application**

- High performance DC/DC
- SR
- Motor Driving
- BMS

**Package**


DFN 3.3\*3.3-8L  
JFG139N30K


**Absolute Maximum Ratings**  $T_C = 25^\circ C$  unless otherwise specified

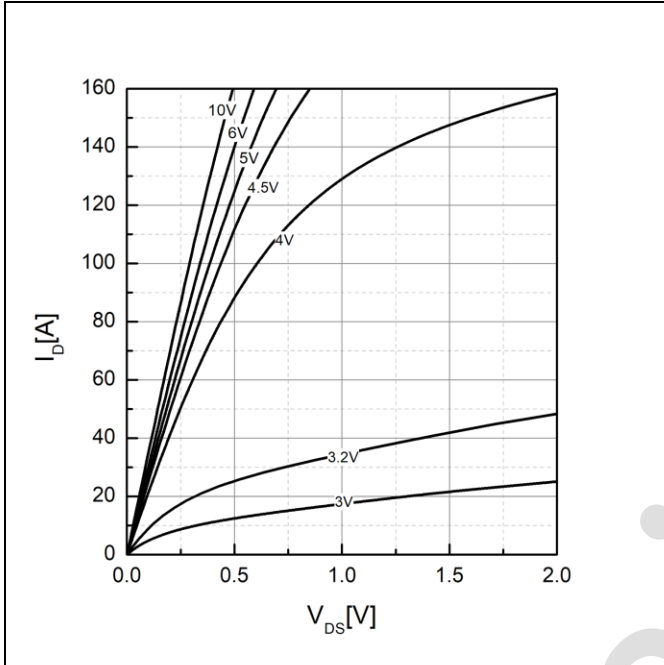
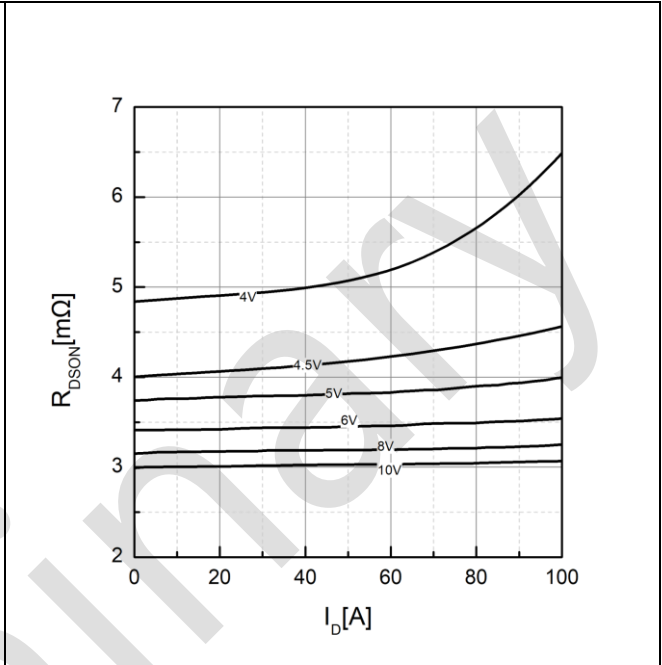
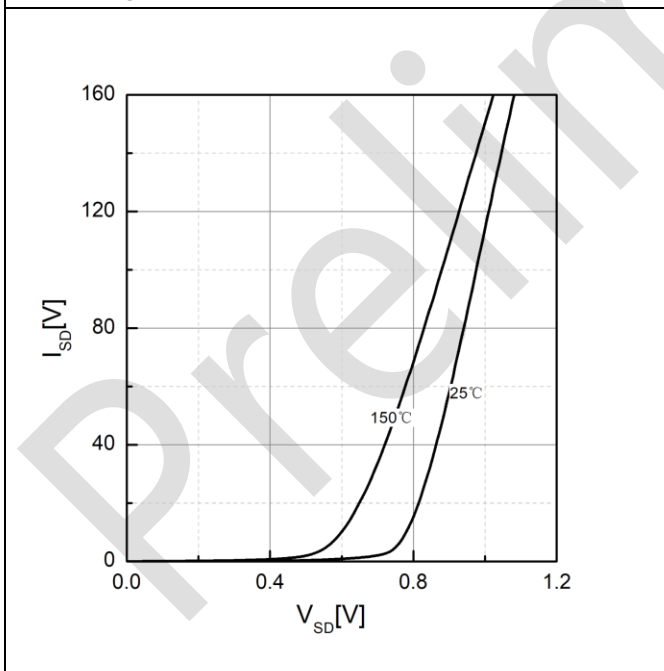
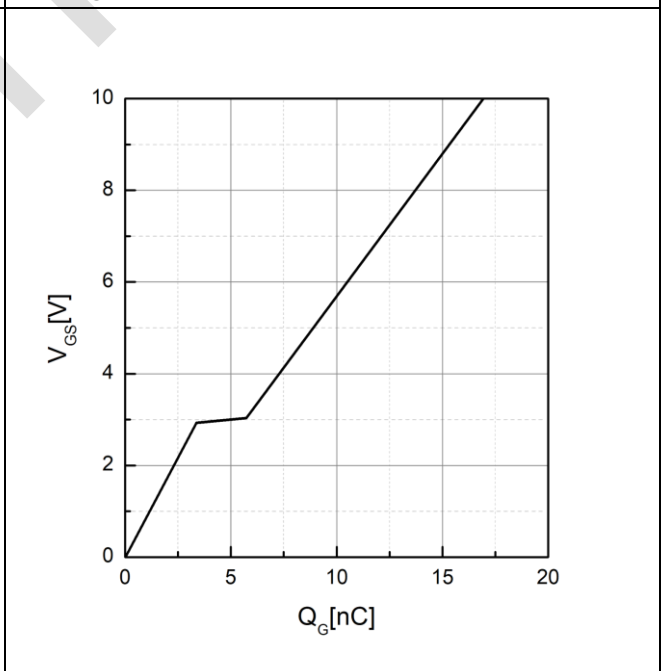
Symbol	Parameter	Max.	Units	
$V_{DS}$	Drain-Source Voltage	30	V	
$V_{GS}$	Gate-Source Voltage	$\pm 20$	V	
$I_D$	Continuous Drain Current, $V_{GS} @ 10V$ <sup>note1</sup>	$T_C = 25^\circ C$	139	A
		$T_C = 100^\circ C$	88	A
$I_{DM}$	Pulsed Drain Current <sup>note2</sup>	556	A	
$P_D$	Power Dissipation <sup>note4</sup>	$T_C = 25^\circ C$	104	W
	Power Dissipation	$T_A = 25^\circ C$	2.08	W
$E_{AS}$	Single Pulsed Avalanche Energy <sup>note3</sup>	73	mJ	
$R_{\theta JC}$	Thermal Resistance, Junction to Case <sup>note1</sup>	1.2	$^\circ C/W$	
$R_{\theta JA}$	Junction to Ambient (mounted on 1 inch square PCB)	60	$^\circ C/W$	
$T_J, T_{STG}$	Operating and Storage Temperature Range	-55 to +150	$^\circ C$	

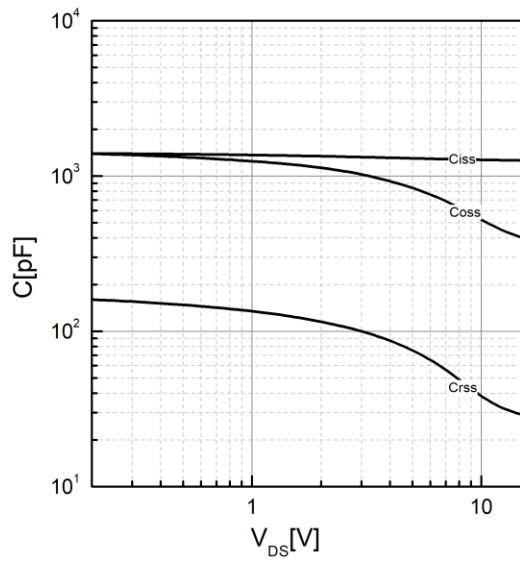
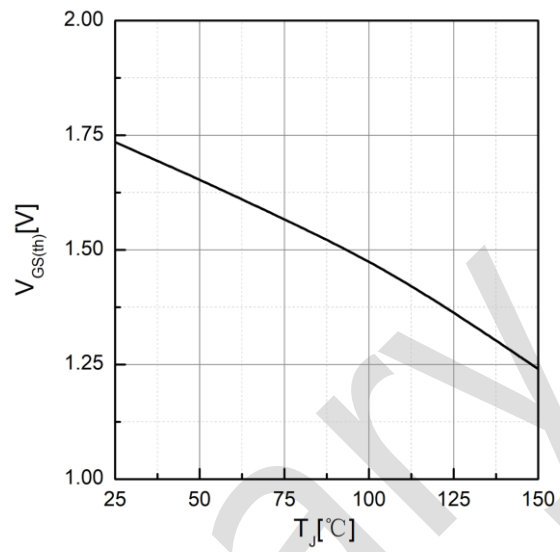
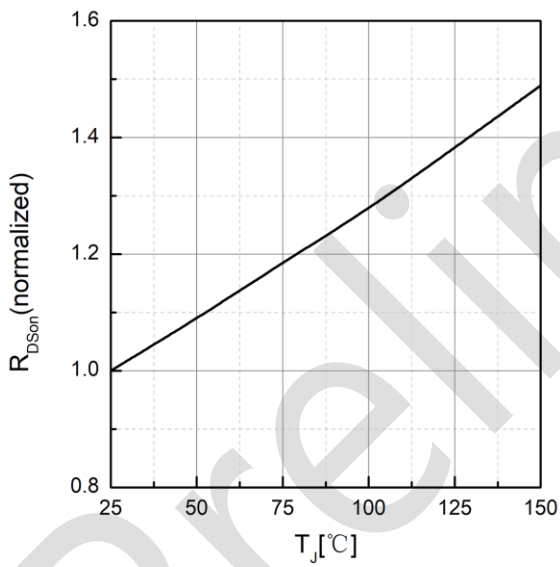
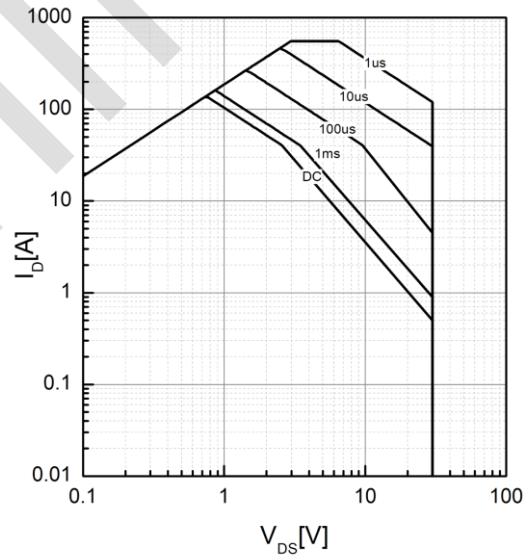
**Electrical Characteristics**  $T_C=25^{\circ}\text{C}$  unless otherwise specified

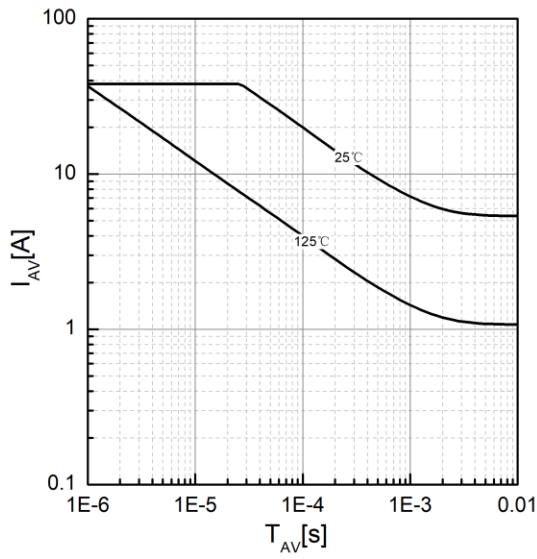
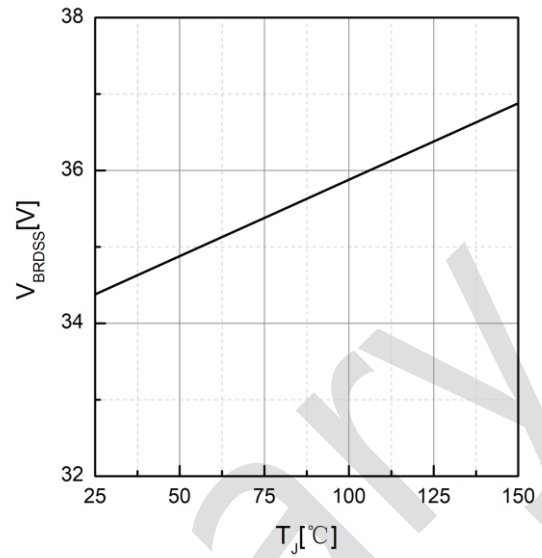
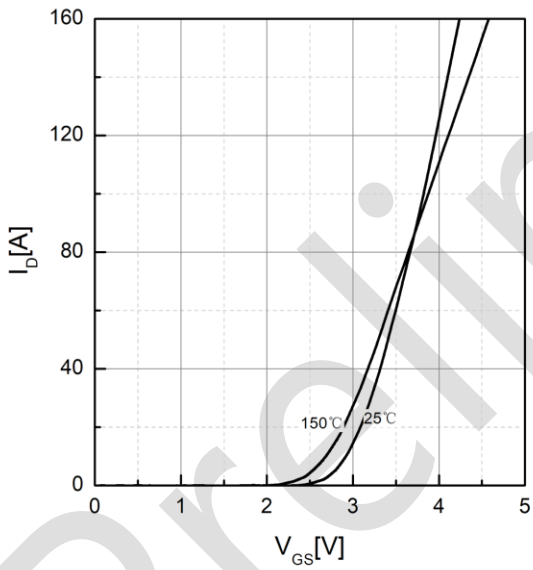
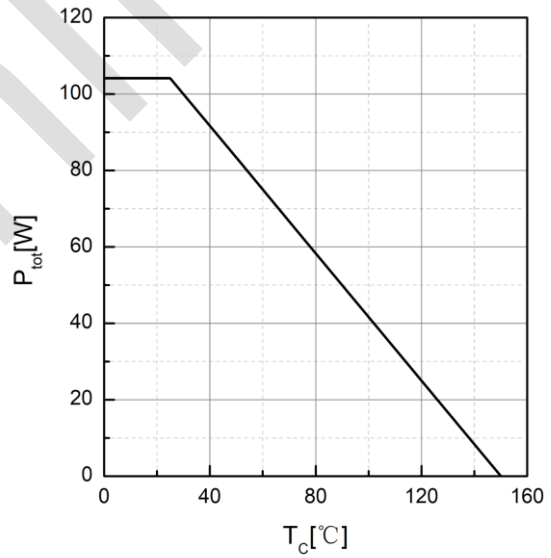
Symbol	Parameter	Test Condition	Min.	Typ.	Max.	Units
<b>Off Characteristic</b>						
$BV_{DSS}$	Drain-Source Breakdown Voltage	$V_{GS} = 0V, I_D = 250\mu A$	30	-	-	V
$I_{DSS}$	Drain-Source Leakage Current	$V_{DS}=30V, V_{GS}= 0V, T_C = 25^{\circ}\text{C}$	-	-	1	$\mu A$
		$V_{DS}=30V, V_{GS}= 0V, T_C = 55^{\circ}\text{C}$	-	-	10	$\mu A$
$I_{GSS}$	Gate-Source Leakage Current	$V_{DS} = 0V, V_{GS} = \pm 20V$	-100	-	100	nA
<b>On Characteristics</b>						
$V_{GS(th)}$	Gate Threshold Voltage	$V_{DS} = V_{GS}, I_D = 250\mu A$	1	-	2.5	V
$R_{DS(on)}$	Static Drain-Source On-Resistance <small>note2</small>	$V_{GS} = 10V, I_D = 30A$	-	3.0	3.6	m $\Omega$
$R_{DS(on)}$	Static Drain-Source On-Resistance <small>note2</small>	$V_{GS} = 4.5V, I_D = 30A$	-	4.1	5.0	m $\Omega$
$g_{FS}$	Forward Transconductance	$V_{DS} = 1V, I_D = 30A$	-	88	-	S
<b>Dynamic Characteristics</b>						
$R_g$	Gate Resistance		-	3.8	-	$\Omega$
$C_{iss}$	Input Capacitance	$V_{DS} = 15V, V_{GS} = 0V,$ $f = 1\text{MHz}$	-	1260	-	pF
$C_{oss}$	Output Capacitance		-	401	-	pF
$C_{rSS}$	Reverse Transfer Capacitance		-	29	-	pF
$Q_g$	Total Gate Charge	$V_{DS} = 15V, I_D = 30A,$ $V_{GS} = 10V$	-	17.5	-	nC
$Q_{gs}$	Gate-Source Charge		-	3.5	-	nC
$Q_{gd}$	Gate-Drain("Miller") Charge		-	2.5	-	nC
<b>Switching Characteristics</b>						
$t_{d(on)}$	Turn-On Delay Time	$V_{DD} = 15V, I_D = 30A,$ $R_G = 1\Omega, V_{GS} = 10V$	-	7	-	ns
$t_r$	Turn-On Rise Time		-	4	-	ns
$t_{d(off)}$	Turn-Off Delay Time		-	45	-	ns
$t_f$	Turn-Off Fall Time		-	5	-	ns
<b>Source-Drain Diode Characteristics and Maximum Ratings</b>						
$I_S$	Maximum Continuous Diode Forward Current <small>note1,5</small>		-	-	86	A
$I_{SM}$	Maximum Pulsed Diode Forward Current <small>note2,5</small>		-	-	556	A
$t_{rr}$	Reverse Recovery Time	$T_J = 25^{\circ}\text{C}, I_S = 30A, V_{GS} = 0V$ $di/dt = 100A/\mu s$	-	40	-	ns
$Q_{rr}$	Reverse Recovery Charge		-	20	-	nC
$V_{SD}$ <small>note2</small>	Source to Drain Diode Forward Voltage	$T_J = 25^{\circ}\text{C}, I_S = 30A, V_{GS} = 0V$	-	0.84	-	V

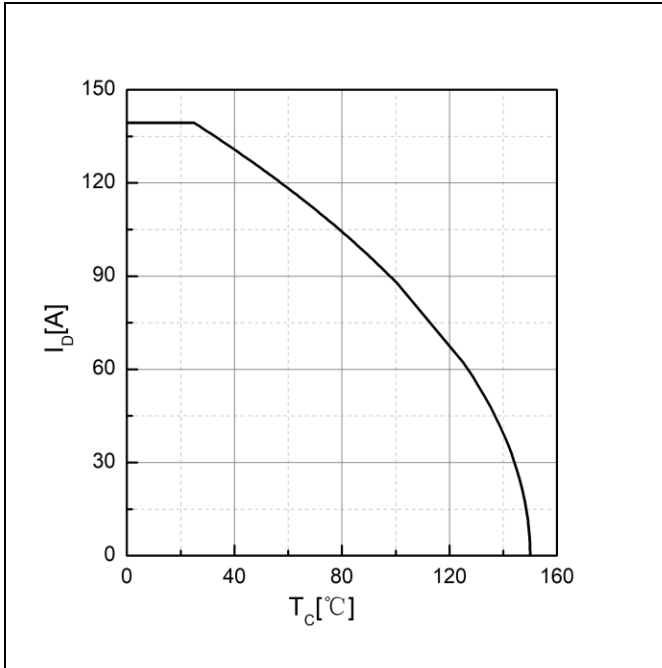
Note :

- The data tested by surface mounted on one inch<sup>2</sup> FR-4 board with 2OZ copper.
- The data tested by pulsed, pulse width  $\leq 300\mu s$ , duty cycle  $\leq 2\%$ .
- The EAS data shows Max. rating. The test condition is  $L=0.1\text{mH}$ ,  $I_{AS}= 38\text{A}$ .
- The power dissipation is limited by  $150^{\circ}\text{C}$  junction temperature.
- The data is theoretically the same as  $I_D$  and  $I_{DM}$ , in real applications, should be limited by total power dissipation.

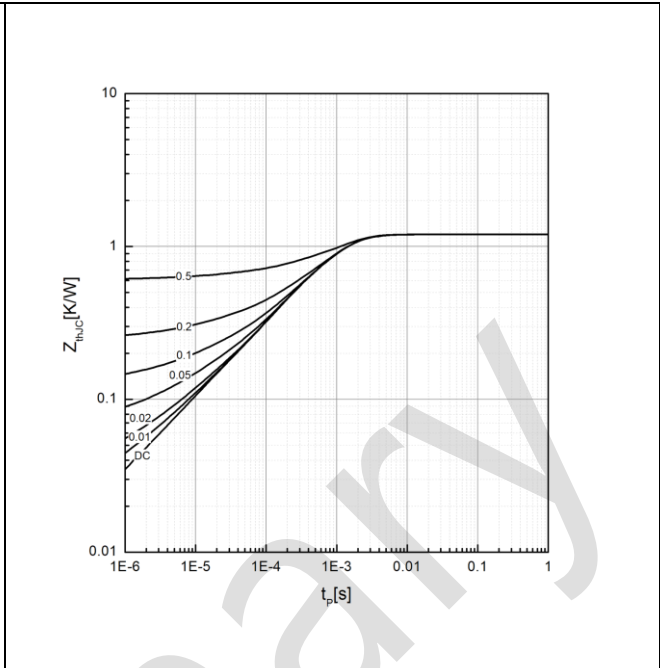
**Typical Performance Characteristics**

**Figure 1. Output Characteristics,  $T_J=25^\circ\text{C}$** 

**Figure 2. Drain-source on resistance ,  $T_J=25^\circ\text{C}$** 

**Figure 3. Forward characteristics of body diode**

**Figure 4. Gate Charge Characteristics**


**Figure 5. Capacitance Characteristics**

**Figure 6. Threshold Voltage Vs. Temperature**

**Figure 7. Drain-source on-state resistance**

**Figure 8. Maximum Safe Operating Area**

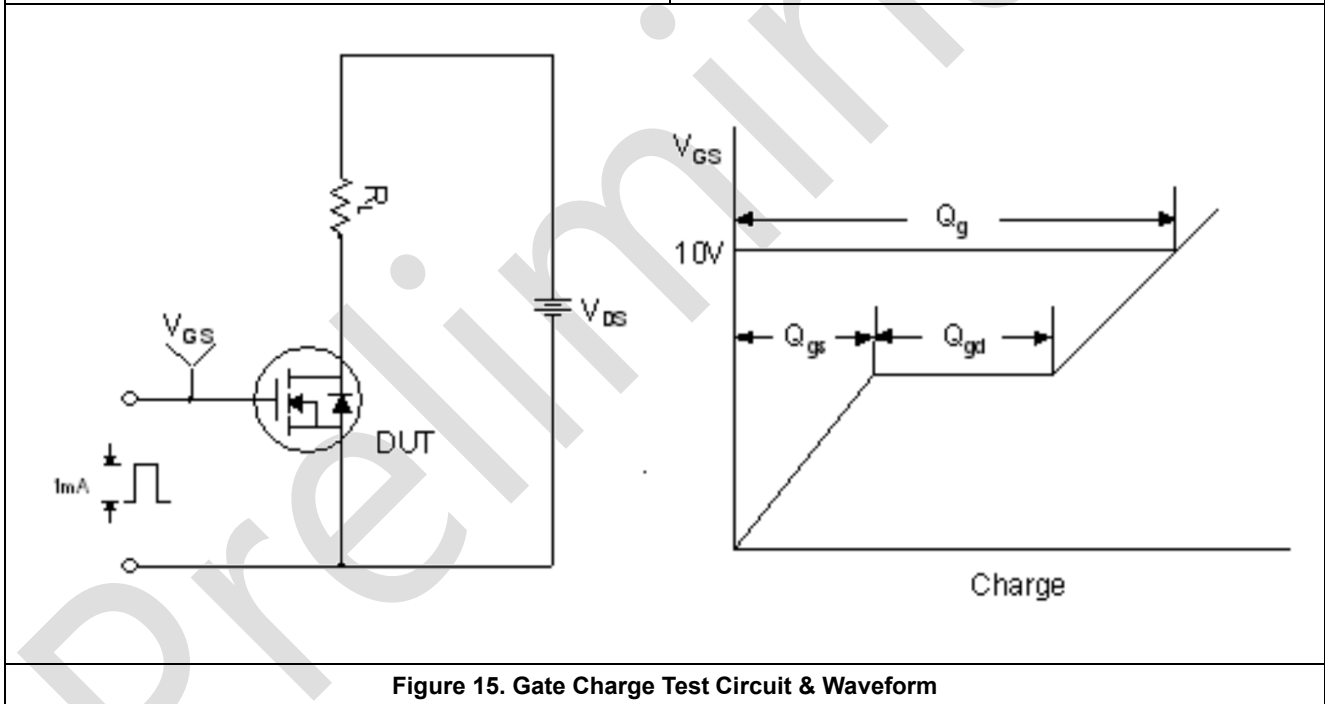

**Figure 9. Avalanche characteristics**

**Figure 10. Drain-source breakdown voltage**

**Figure 11. Transfer characteristics**

**Figure 12. Power dissipation**



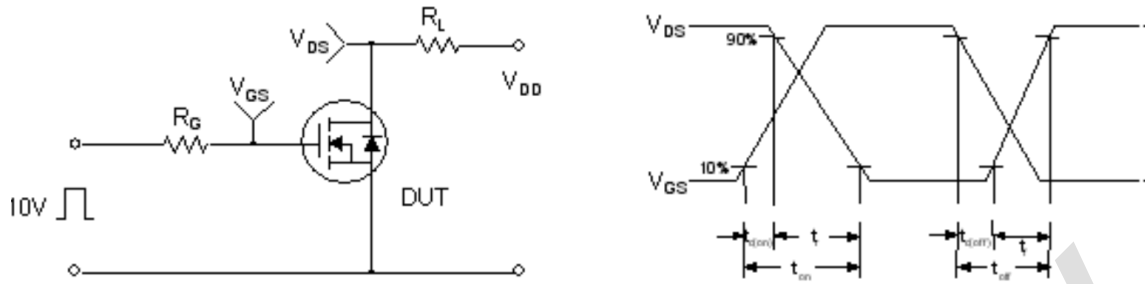
**Figure 13. Drain current**



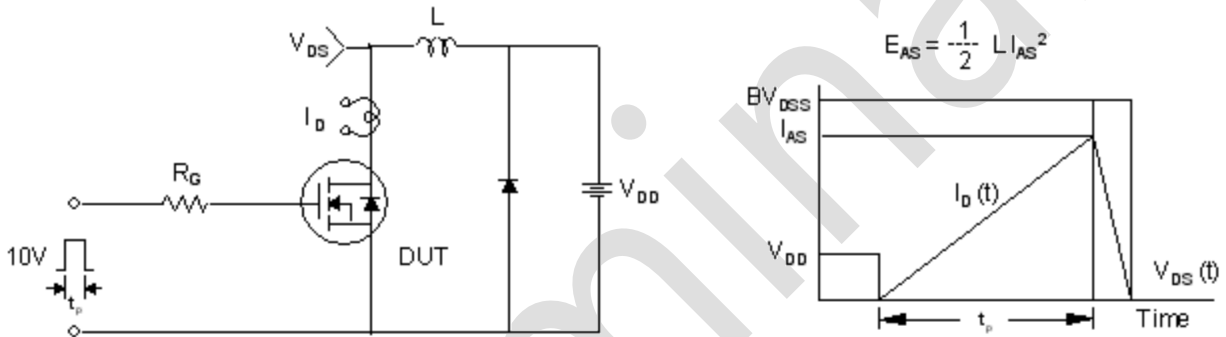
**Figure 14. Effective Transient Thermal Impedance**



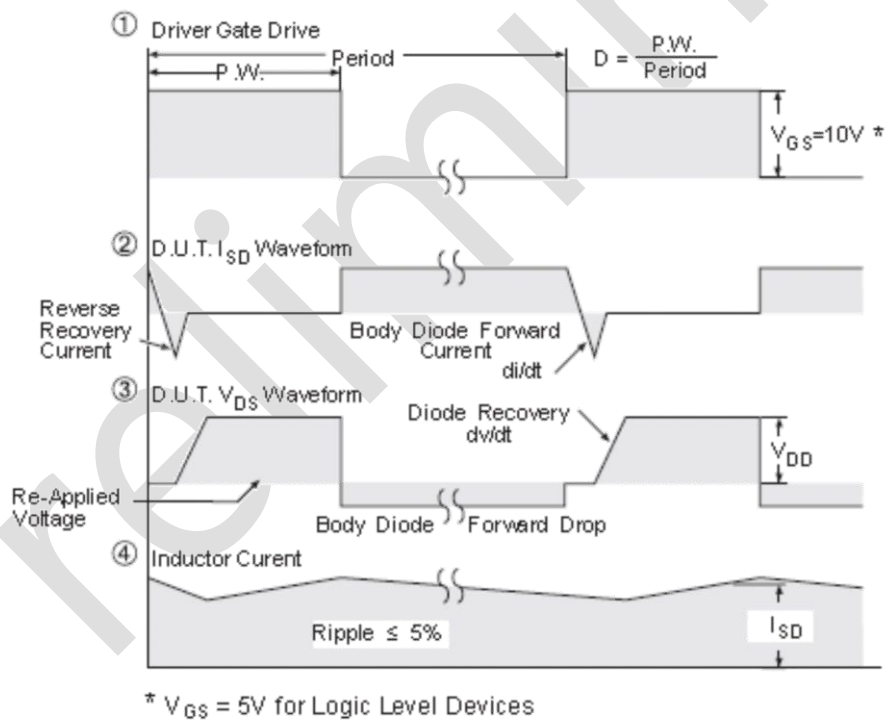
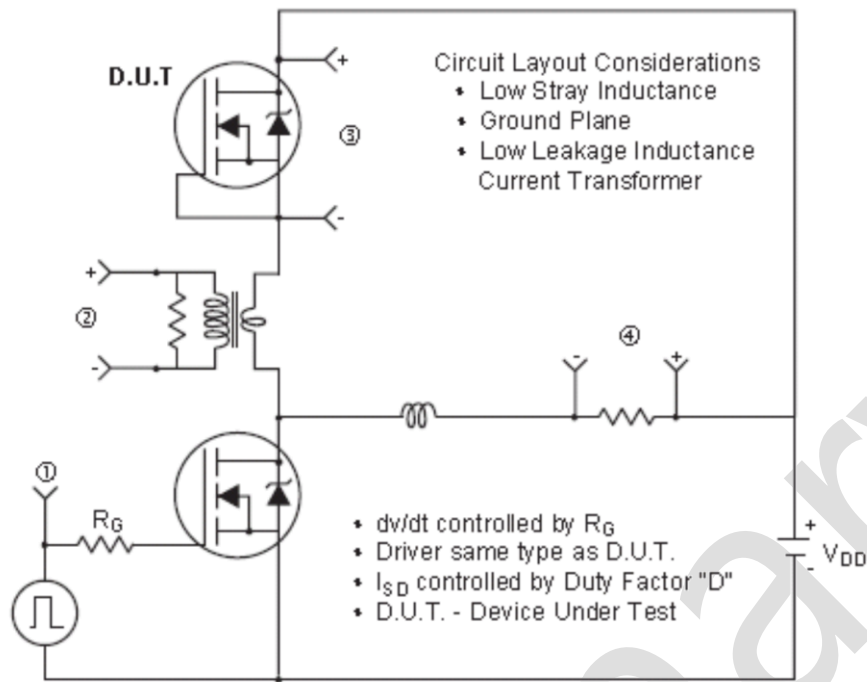
**Figure 15. Gate Charge Test Circuit & Waveform**



**Figure 16. Resistive Switching Test Circuit & Waveforms**

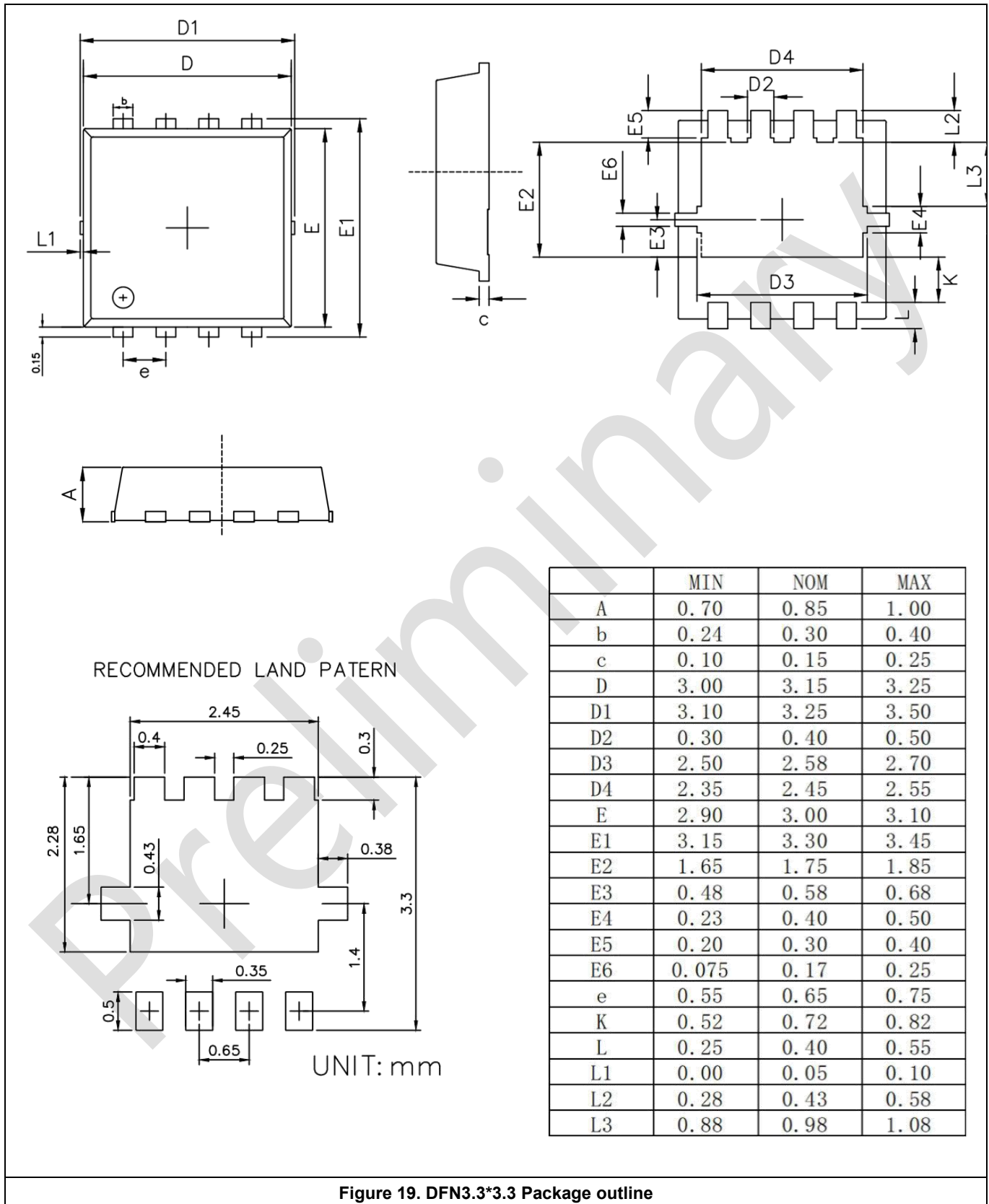


**Figure 17. Unclamped Inductive Switching Test Circuit & Waveforms**



**Figure 18. Peak Diode Recovery  $dv/dt$  Test Circuit & Waveforms (For N-channel)**



**Package outline**

**Figure 19. DFN3.3\*3.3 Package outline**

**Disclaimer:**

JUNSHINE does not give any representations or warranties, expressed or implied, as to the accuracy or completeness of such information and shall have no liability for the consequences of use of such information.

JUNSHINE reserves the right to make changes to information published in this document, including without limitation specifications and product descriptions, at any time and without notice. This document supersedes and replaces all information supplied prior to the publication hereof.

JUNSHINE makes no warranty, representation or guarantee regarding the suitability of the products for any particular purpose or the continuing production of any product. To the maximum extent permitted by applicable law, JUNSHINE disclaims (1) any and all liability arising out of the application or use of any product, (2) any and all liability, including without limitation special, consequential or incidental damages, and (3) any and all implied warranties, including warranties of fitness for particular purpose, non-infringement and merchantability.

JUNSHINE products, except as expressly indicated in writing, are not designed for use in medical, life-saving, or life-sustaining applications, or for any other application in which the failure of the JUNSHINE product could result in personal injury or death. Customers using or selling JUNSHINE products not expressly indicated for use in such applications do so at their own risks.

Resale of JUNSHINE products with statements different from or beyond the parameters stated by JUNSHINE for that product or service voids all express or implied warranties for the associated JUNSHINE product or service and is unfair and deceptive business practice. JUNSHINE is not responsible or liable for any such statements.

No license, express or implied, by estoppel or otherwise, to any intellectual property rights is granted by this document or by any conduct of JUNSHINE. Product names and markings noted herein may be trademarks of their respective owners.

JUNSHINE IS A FULLY OWNED SUBSIDIARY OF Wuxi XICHANWEIXIN Semiconductor Co., Ltd.